

Area of a Compound Shape

Find the area of the compound shape.

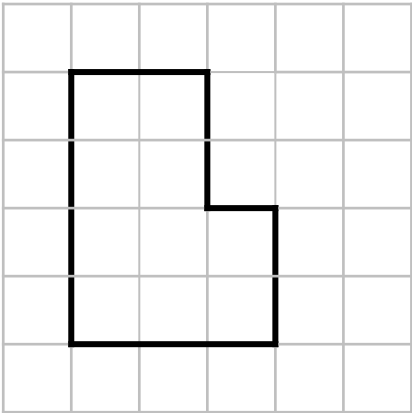

Area:

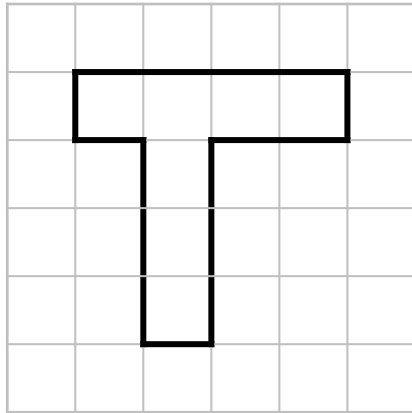

Area:

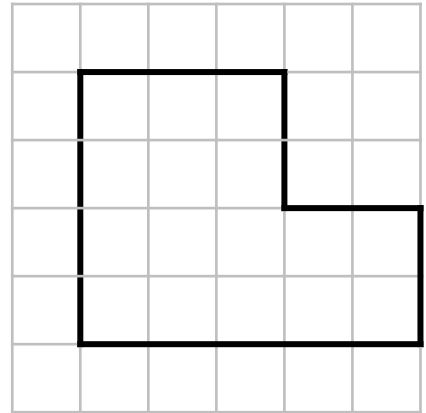

Area:

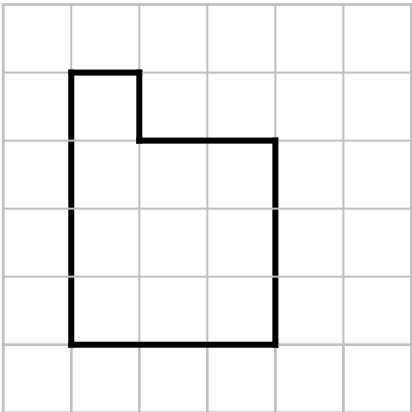

Area:

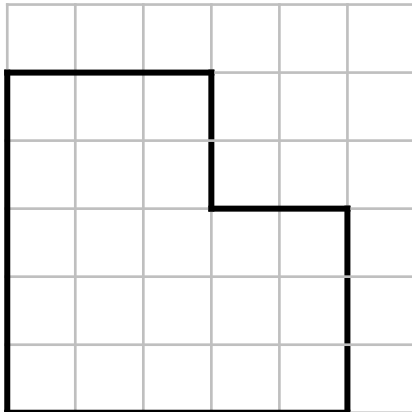

Area:

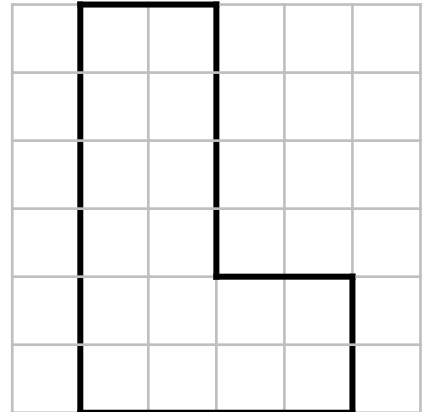

Area:

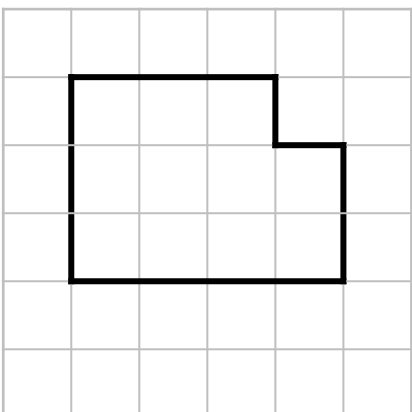

Area:

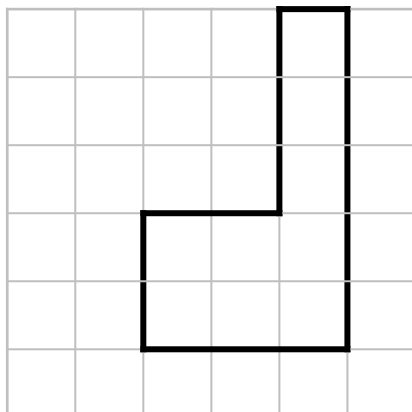

Area:

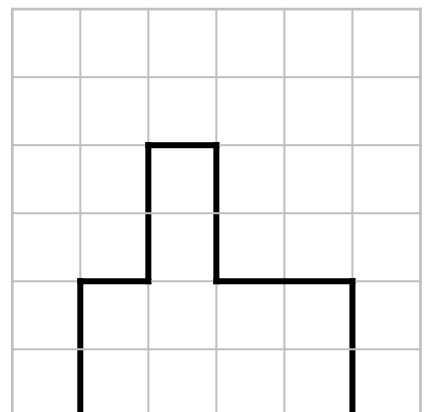

Area:



Area of a Compound Shape

Find the area of the compound shape.

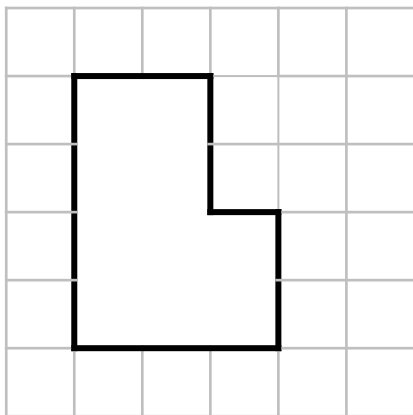

Area:

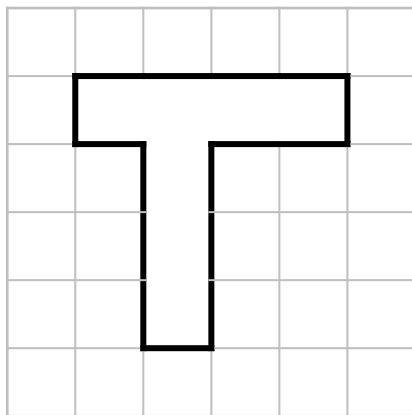

Area:

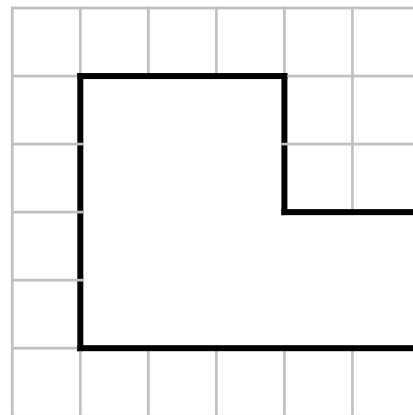

Area:

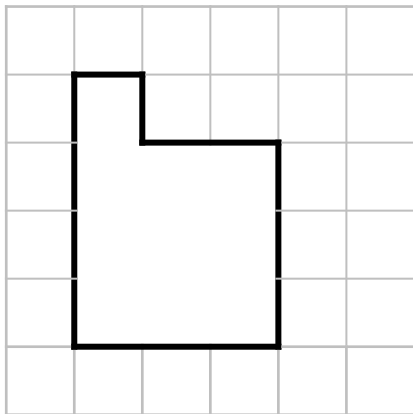

Area:

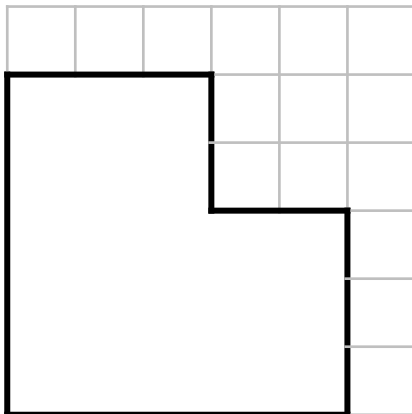

Area:

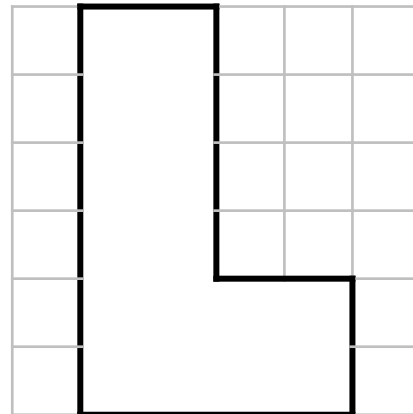

Area:

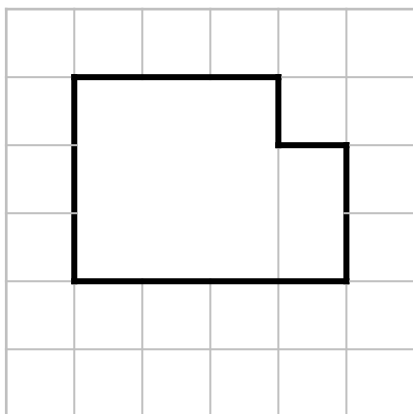

Area:

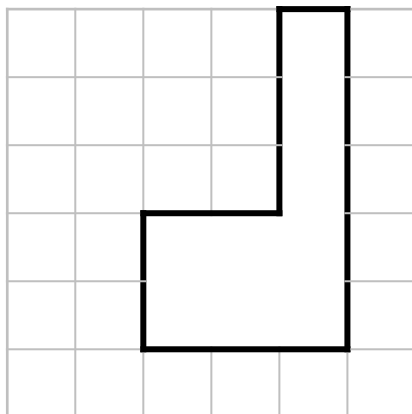

Area:

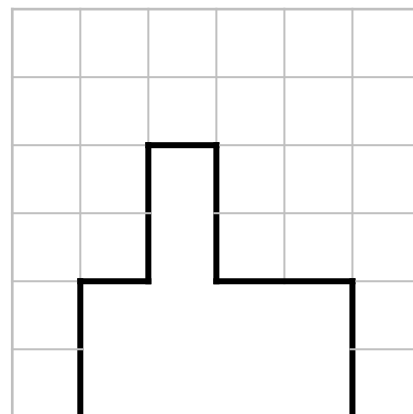

Area:



Area of a Compound Shape

Find the area of the compound shape.

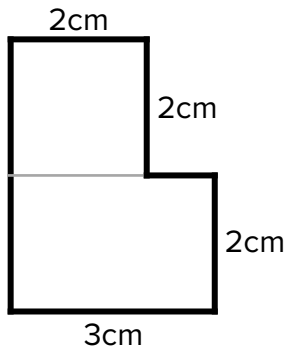

Area:

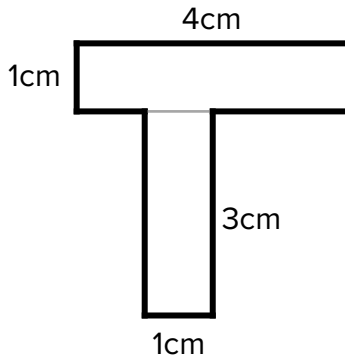

Area:

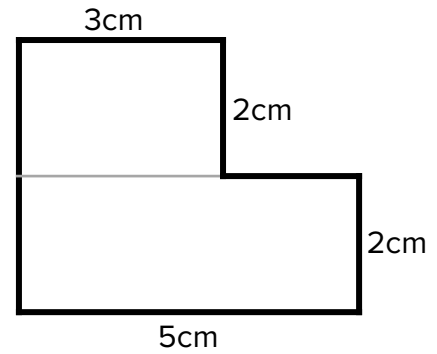

Area:

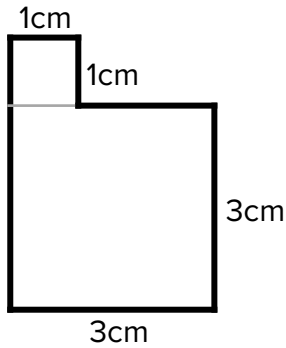

Area:

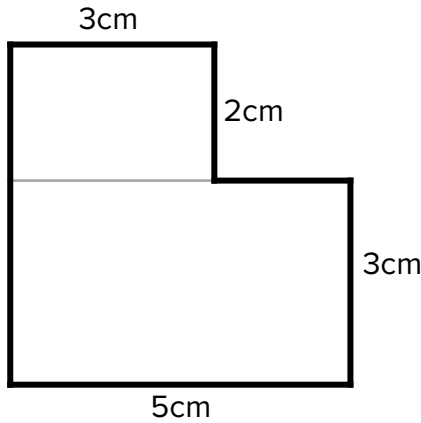

Area:

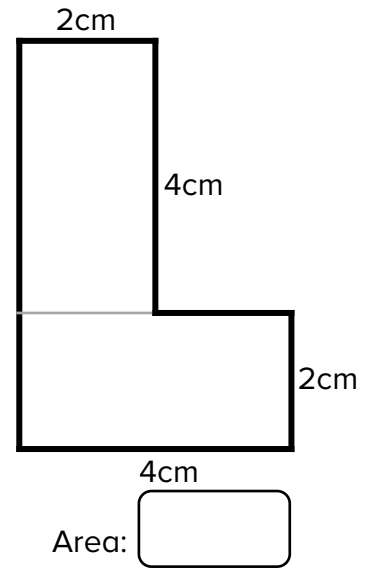

Area:

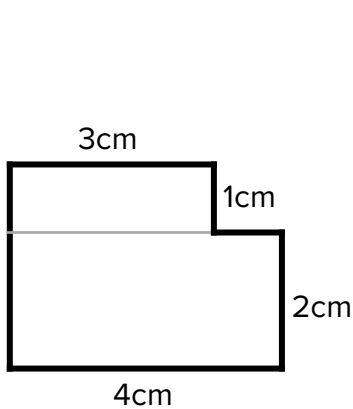

Area:

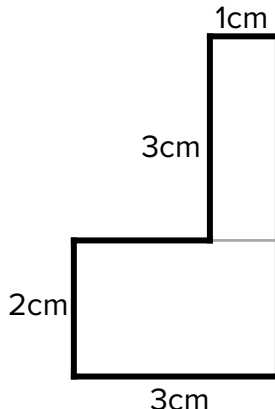

Area:

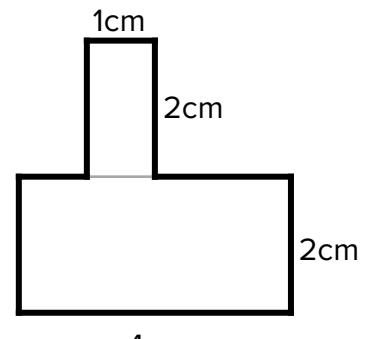

Area:



Area of a Compound Shape

Find the area of the compound shape.

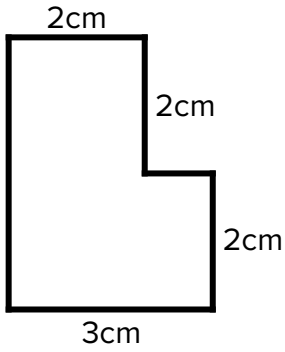

Area:

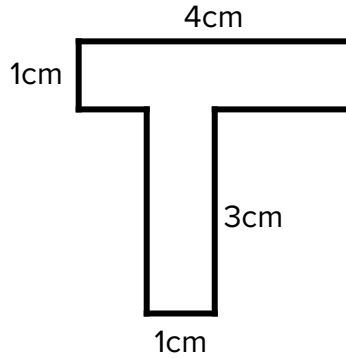

Area:

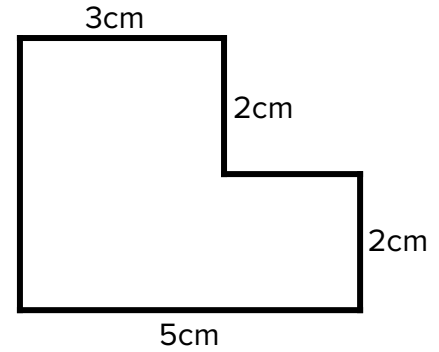

Area:

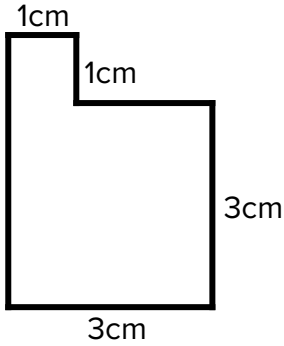

Area:

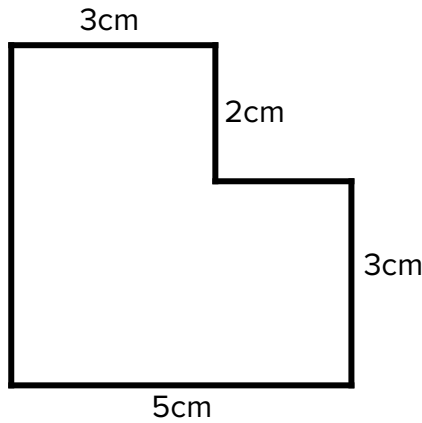

Area:

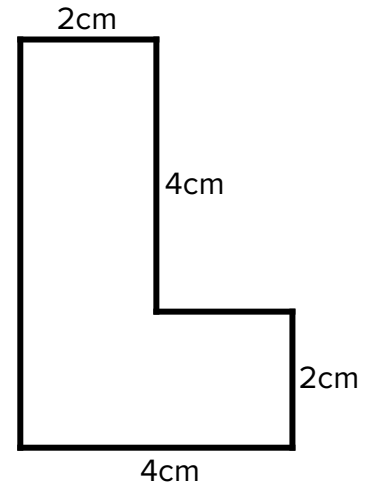

Area:

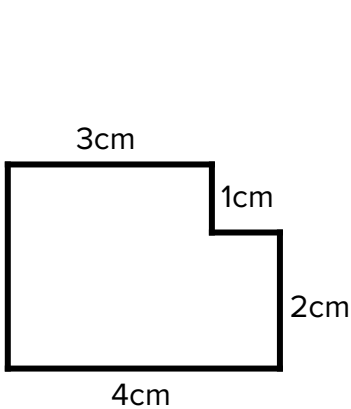

Area:

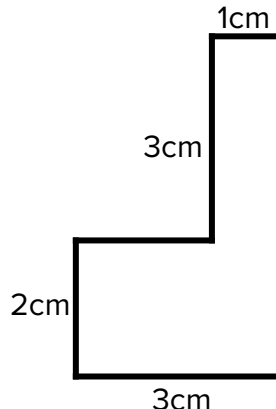

Area:

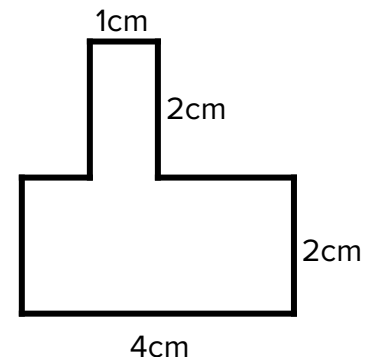

Area:

