

Traceable Numbers

0 to 10

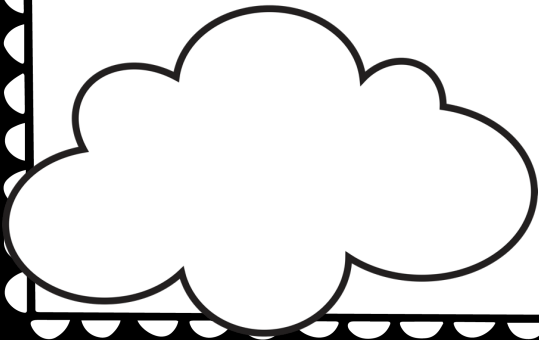

Name: _____

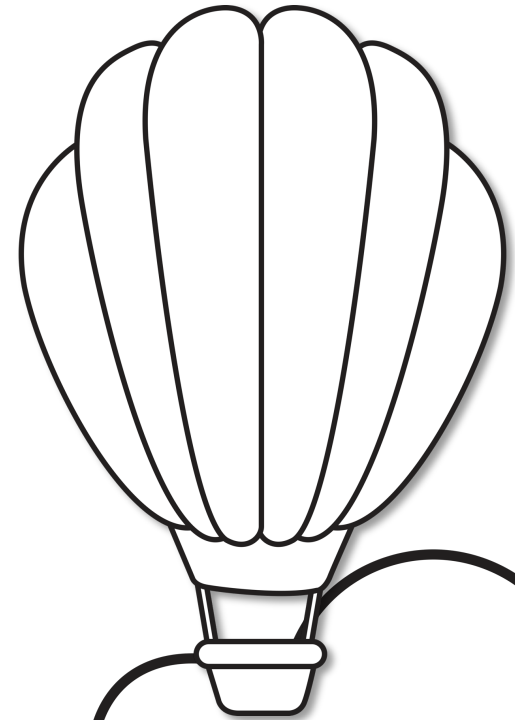
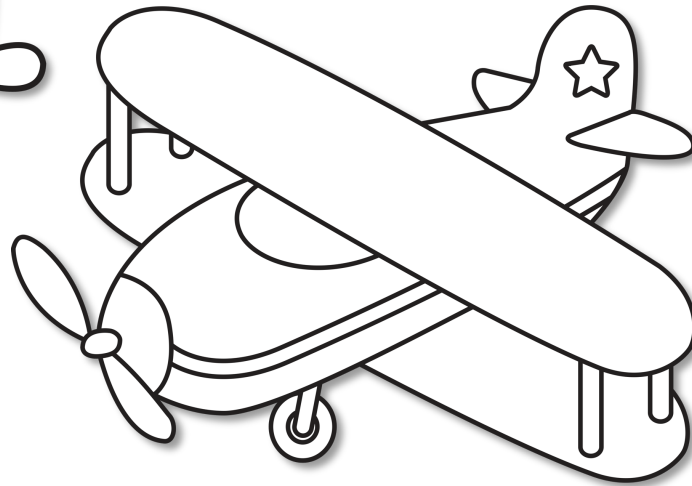
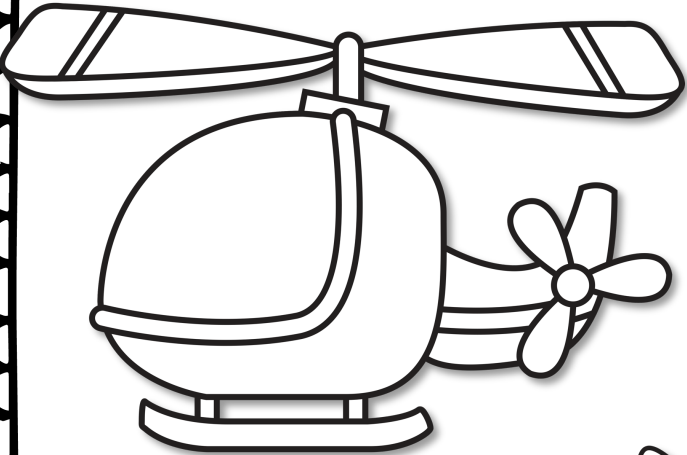
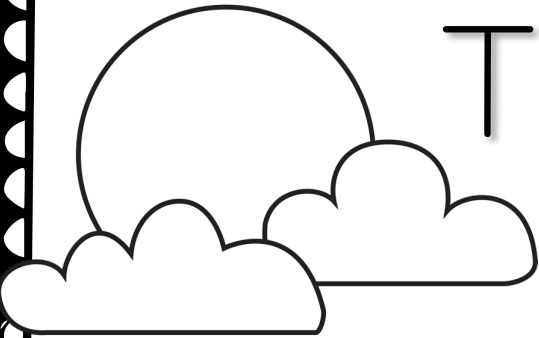

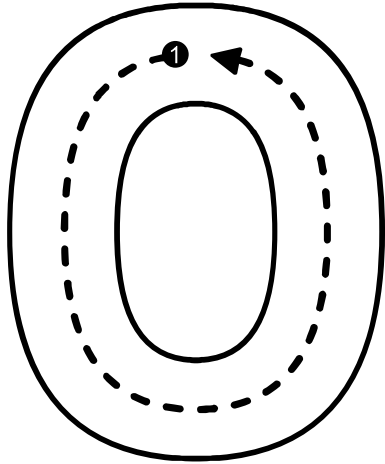

Shade the picture with 1 in it.

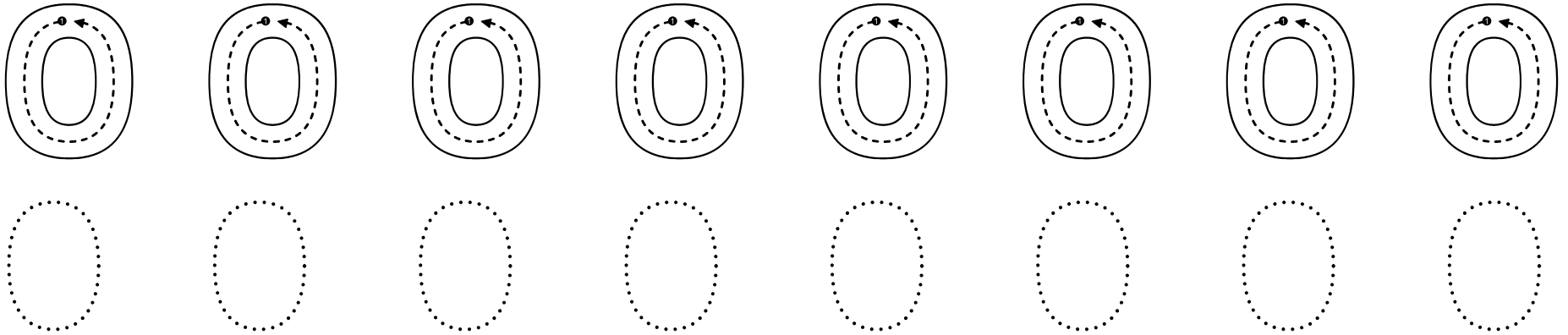
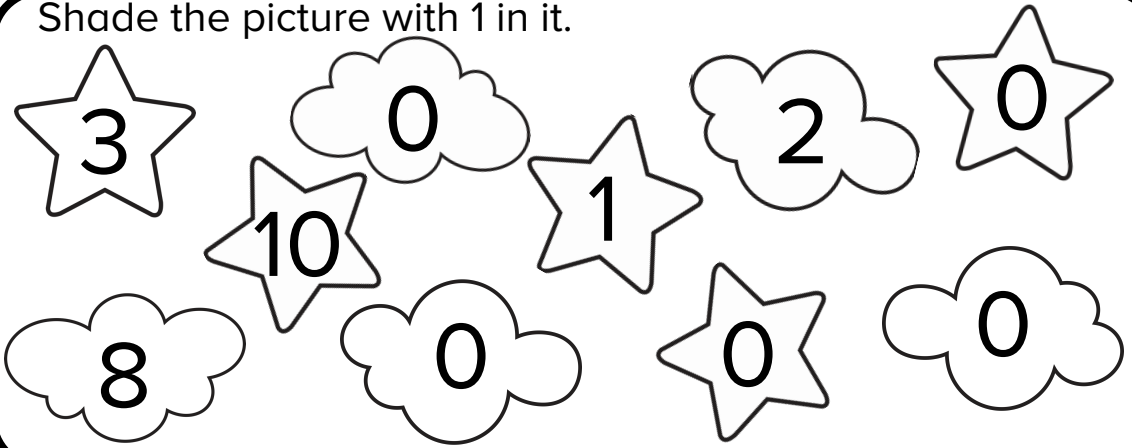

Circle the box with 1 picture in it.

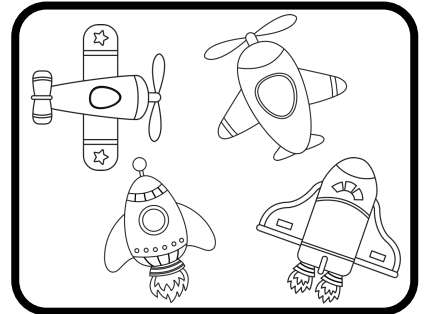
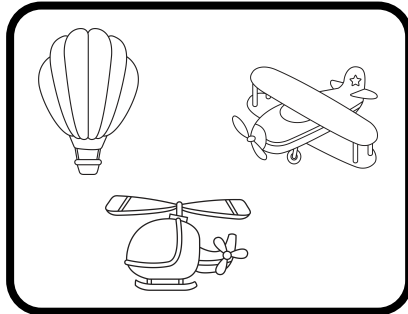
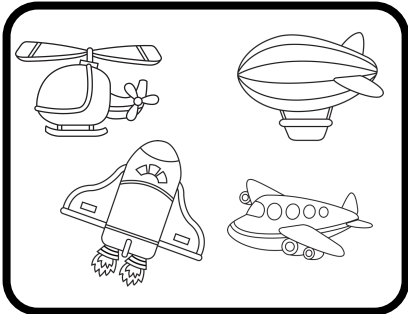

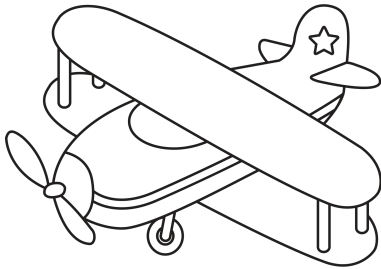
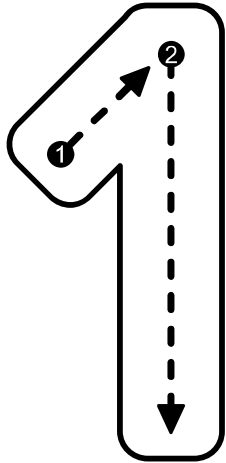

Shade the picture with 1 in it.

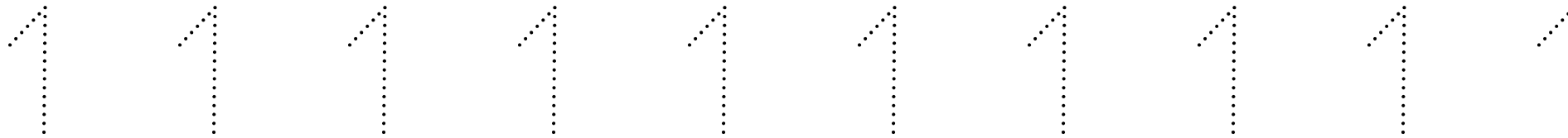
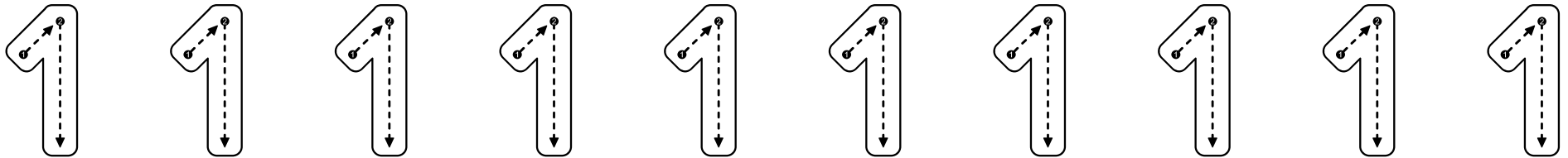
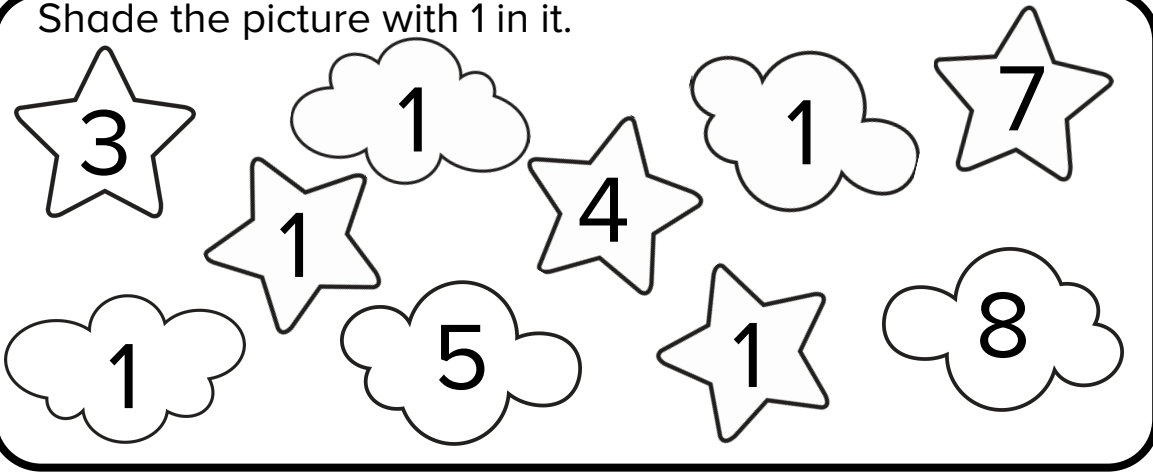

Circle the box with 1 picture in it.

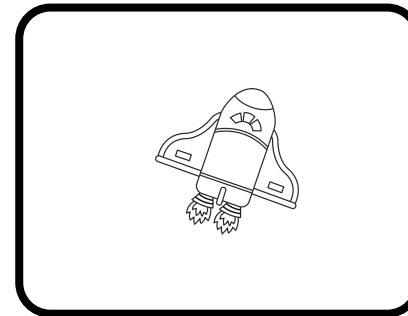
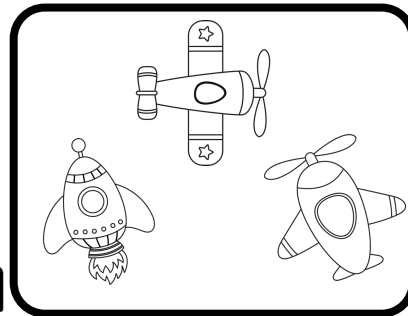
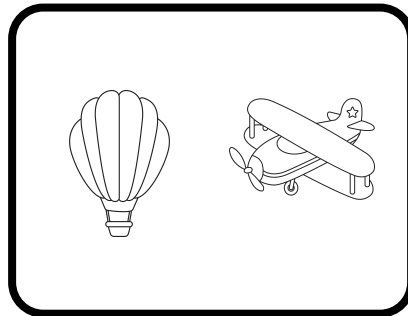
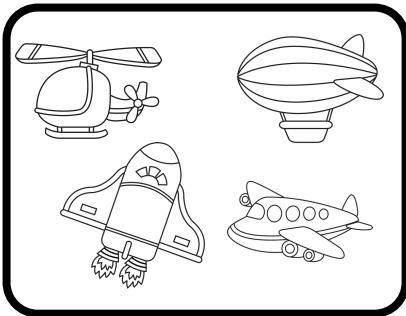

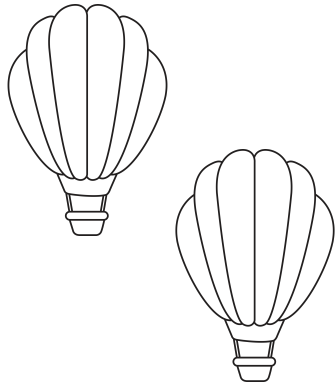
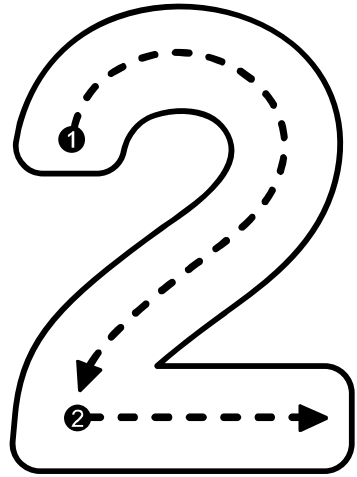

Shade the picture with 2 in it.

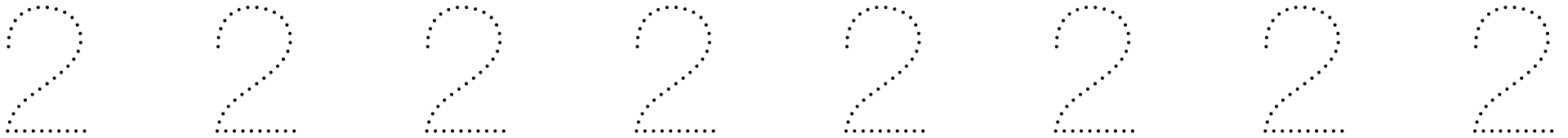
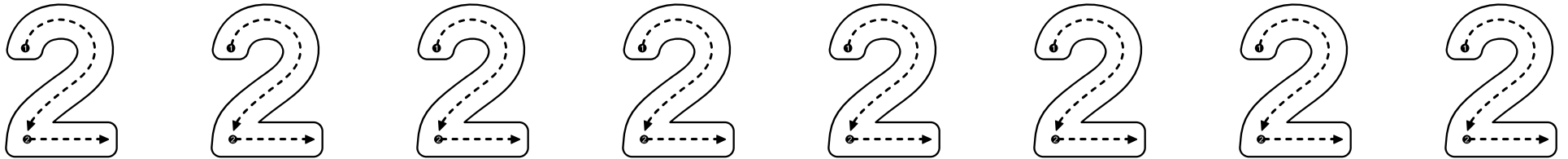
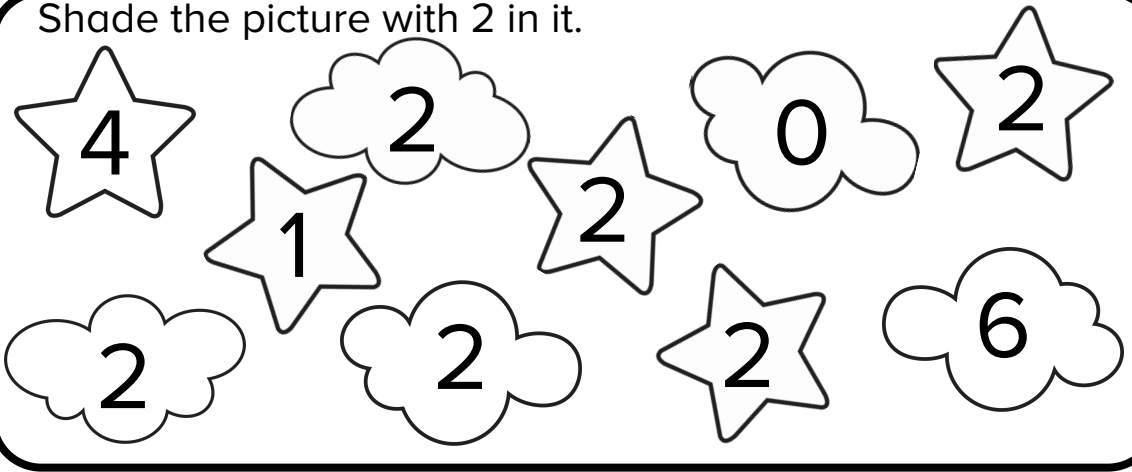

Circle the box with 2 pictures in it.

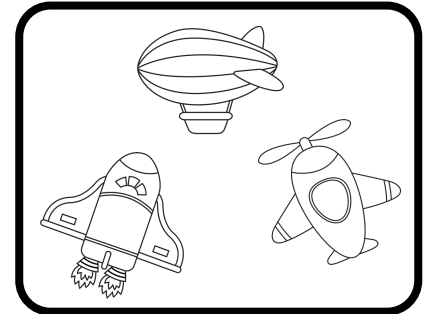
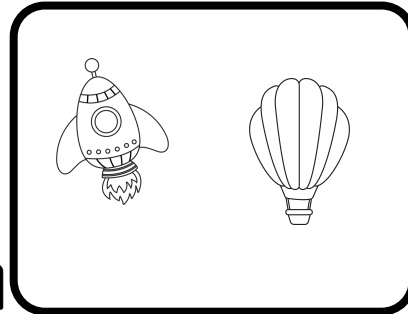
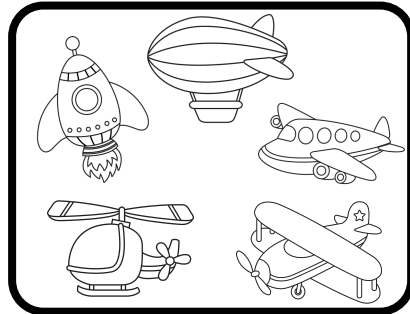
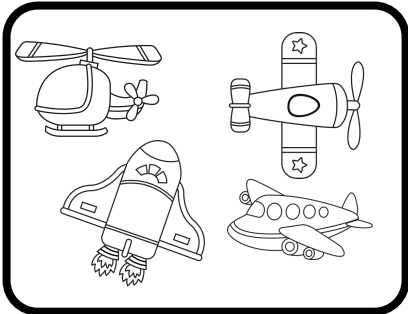

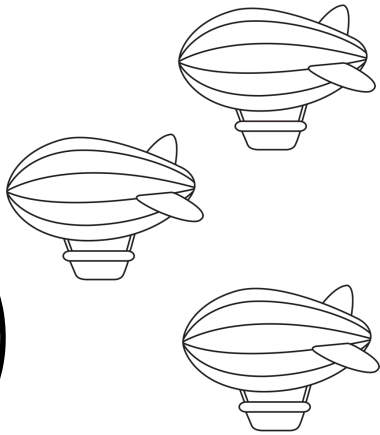
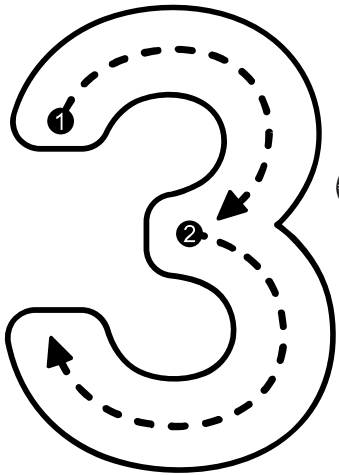

Shade the picture with 3 in it.

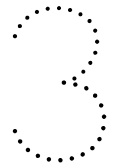
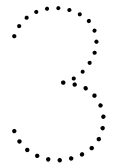
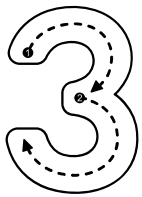
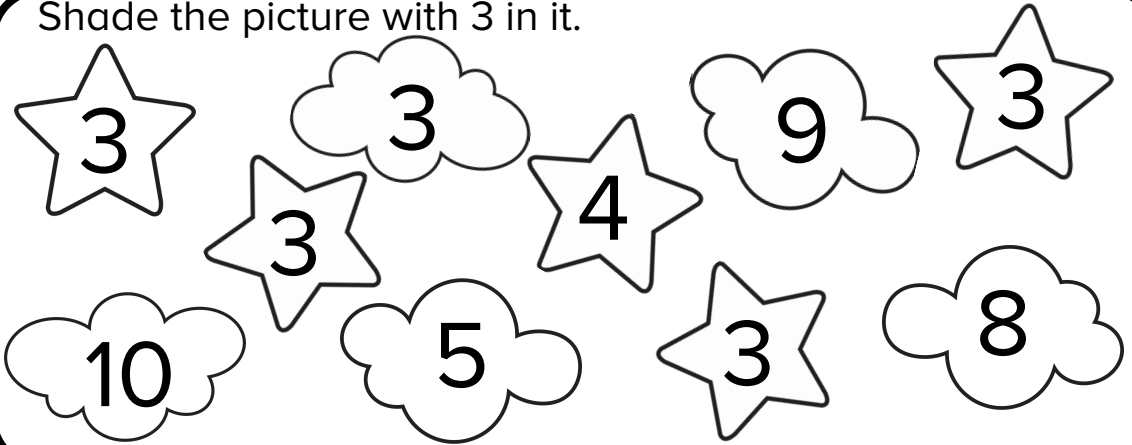

Circle the box with 3 picture in it.

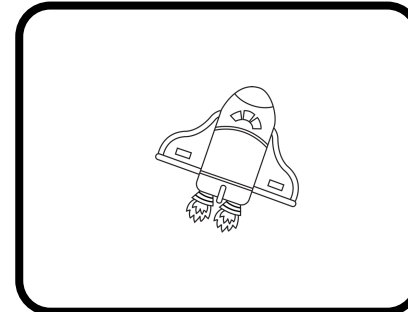
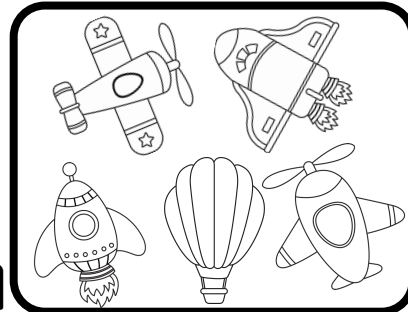
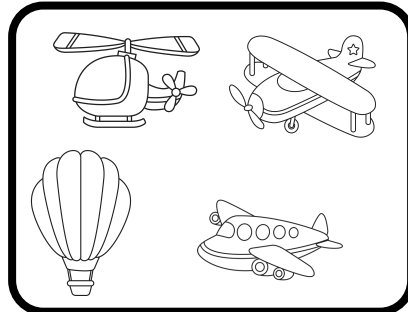
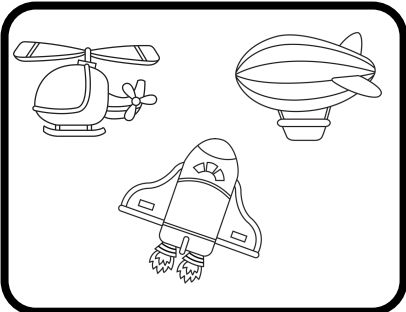

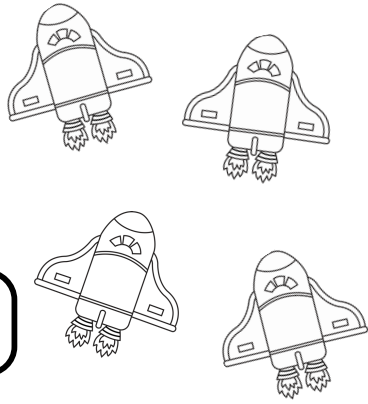
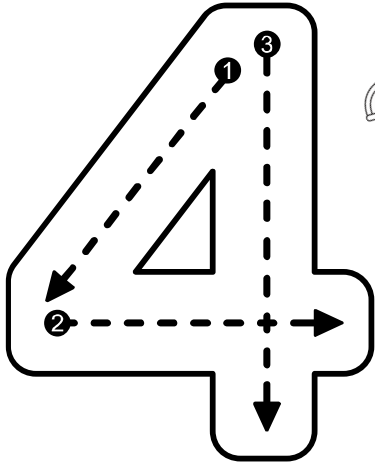

Shade the picture with 4 in it.

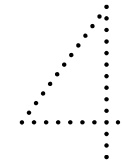
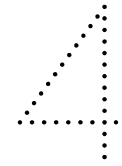
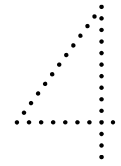
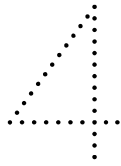
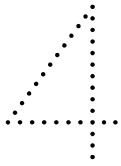
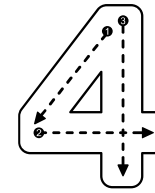
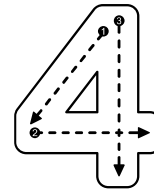
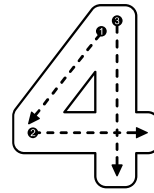
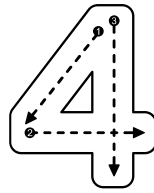
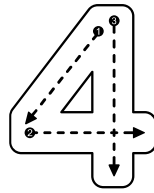
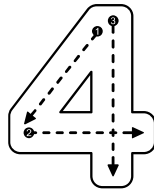
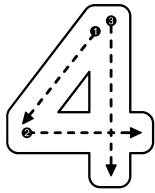
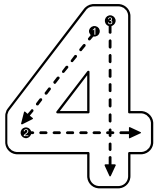
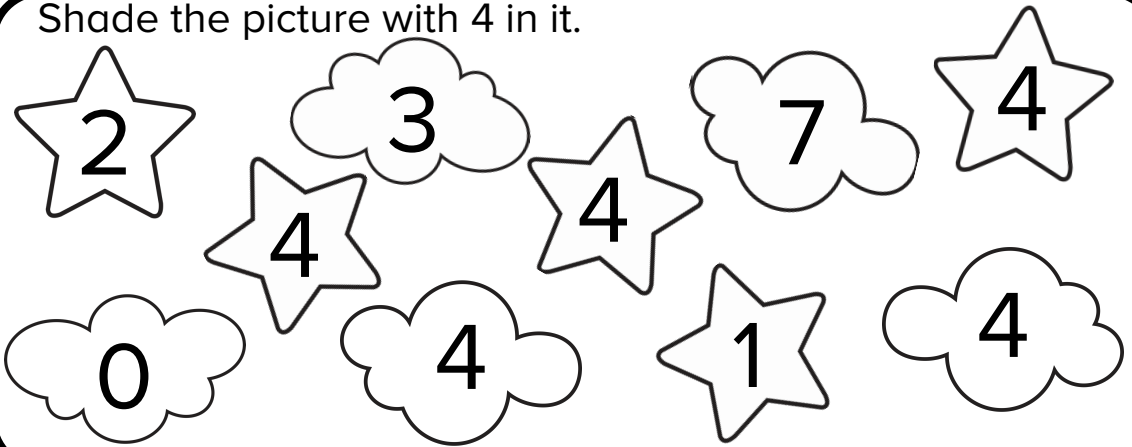

Circle the box with 4 picture in it.

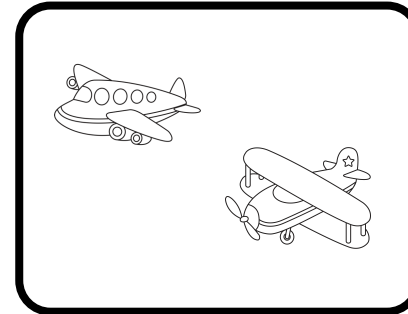
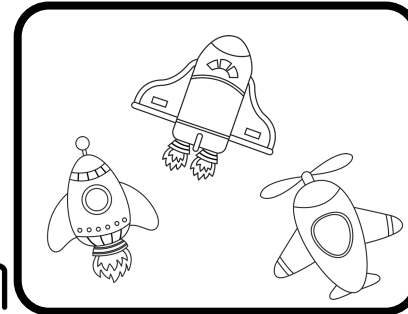
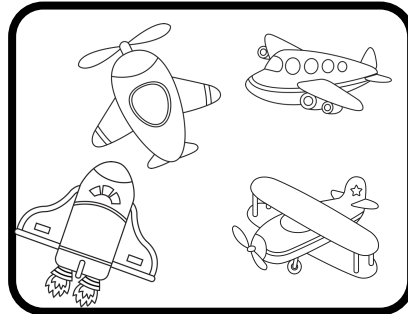
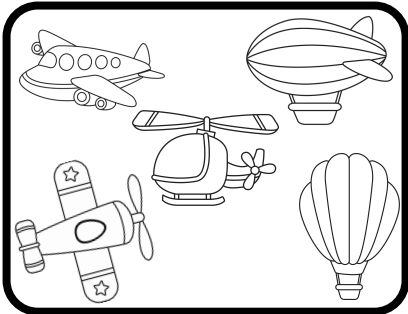

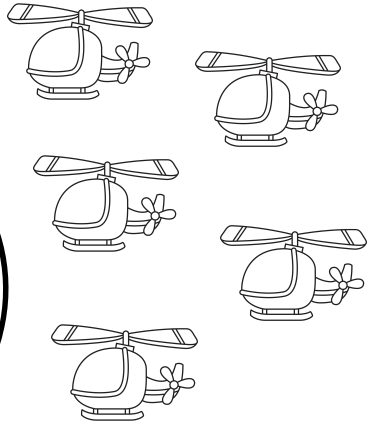
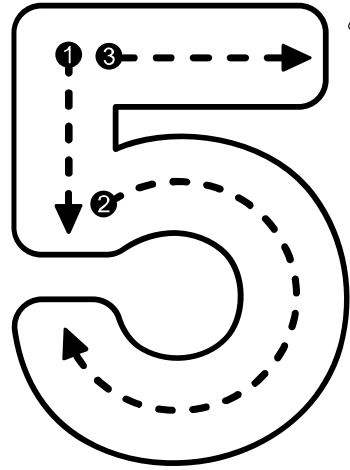

Shade the picture with 5 in it.

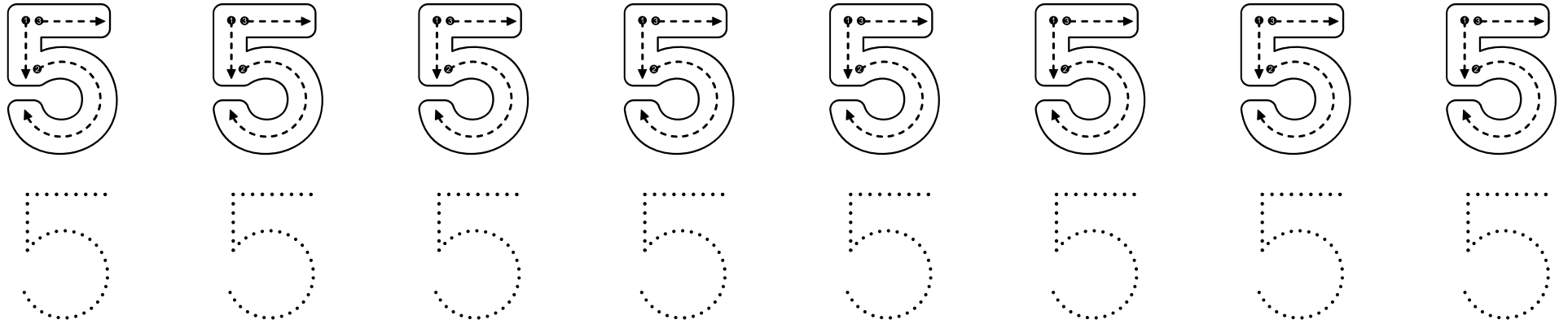
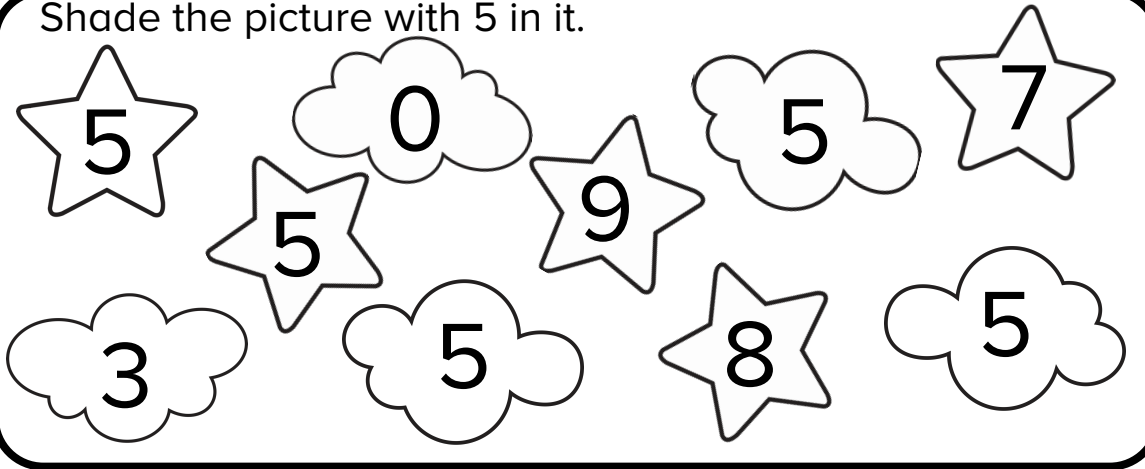

Circle the box with 5 picture in it.

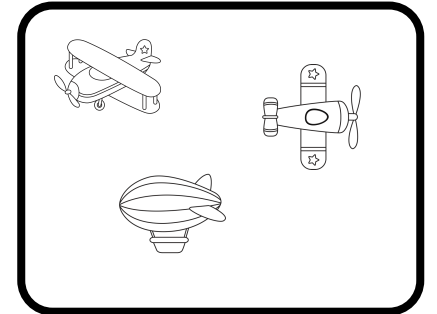
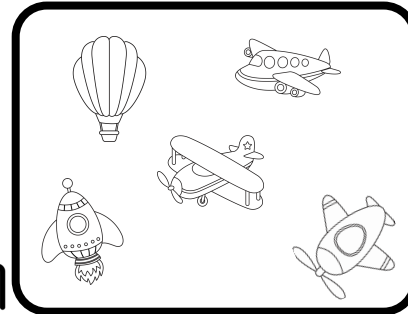
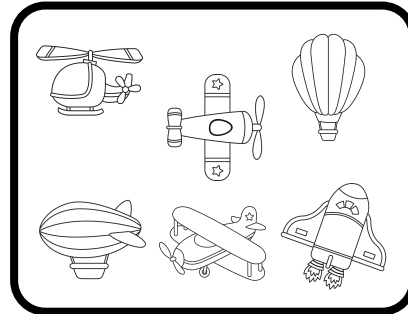
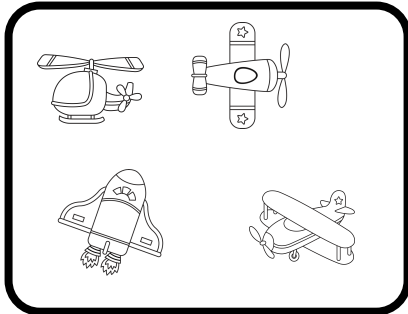

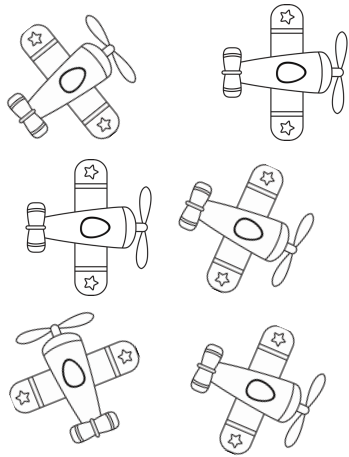
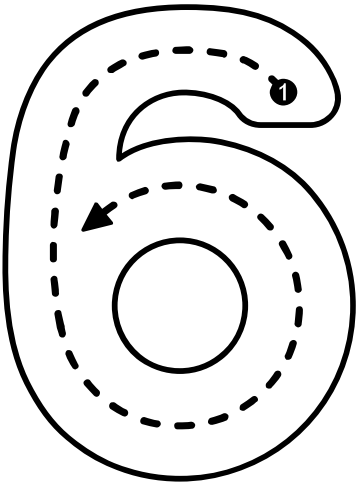

Shade the picture with 6 in it.

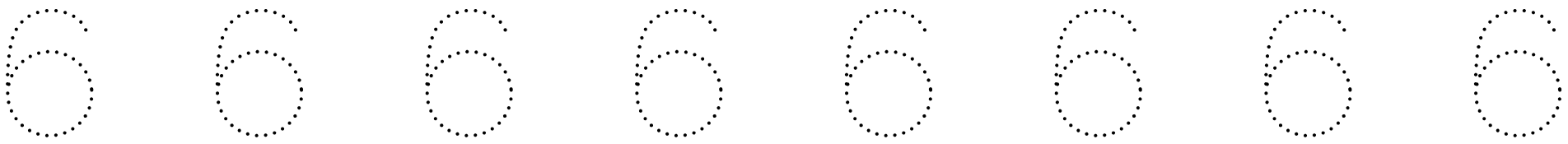
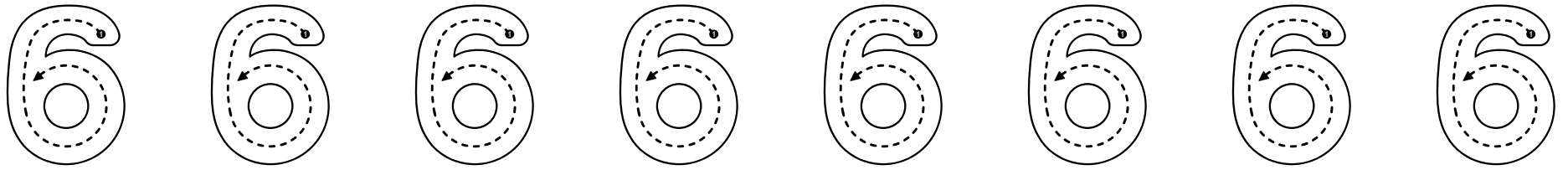
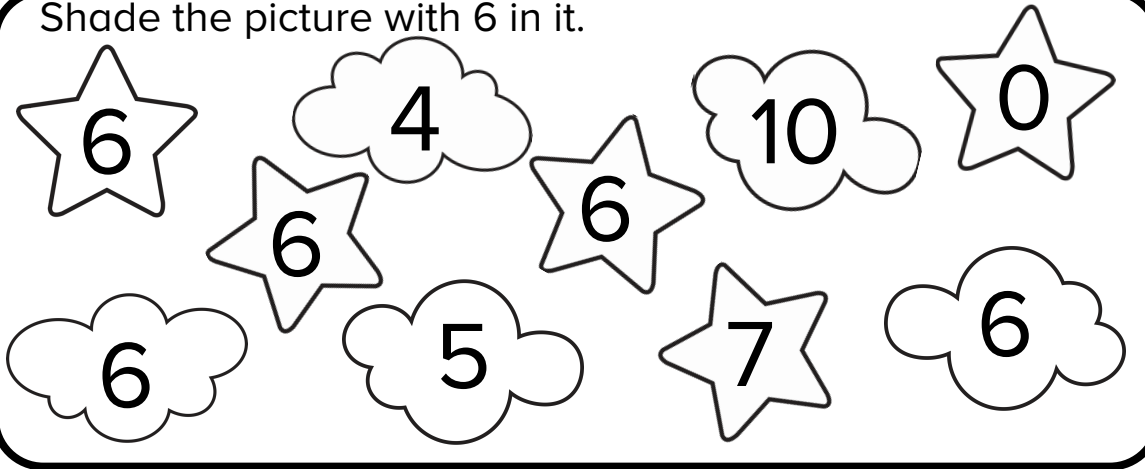

Circle the box with 6 picture in it.

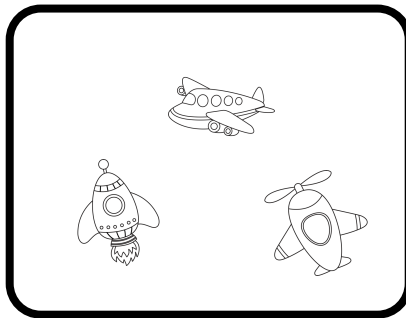
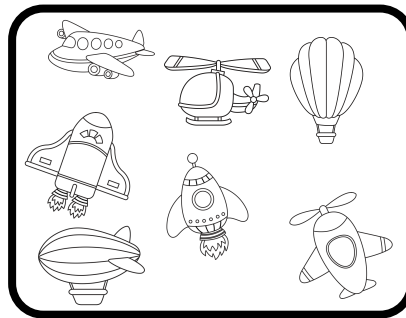
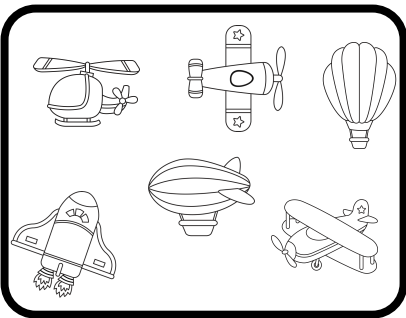

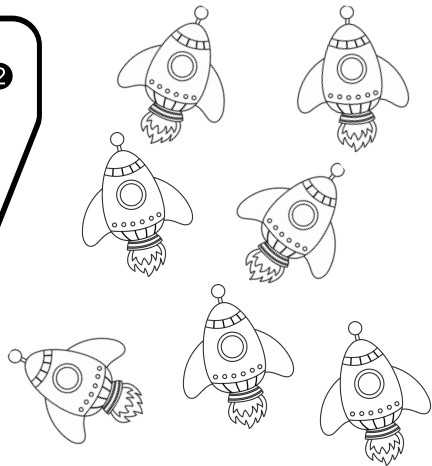
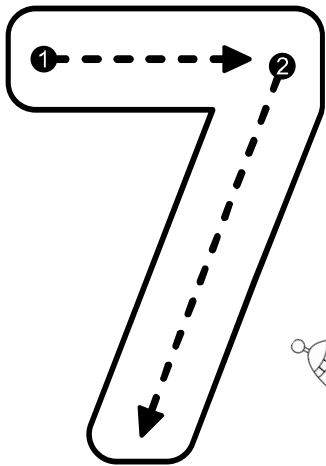

Shade the picture with 7 in it.

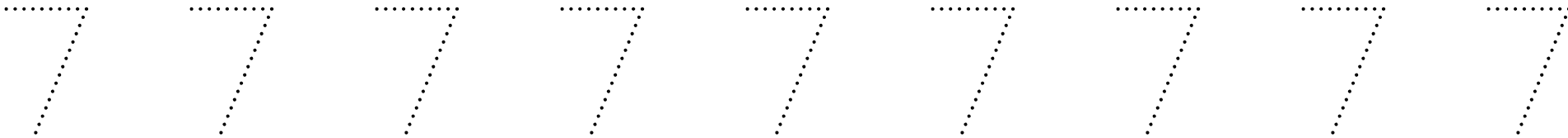
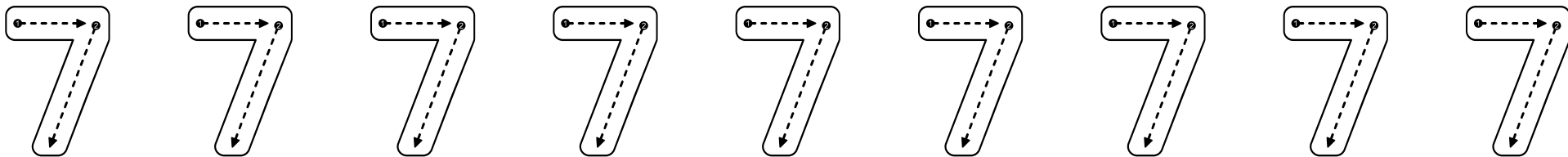
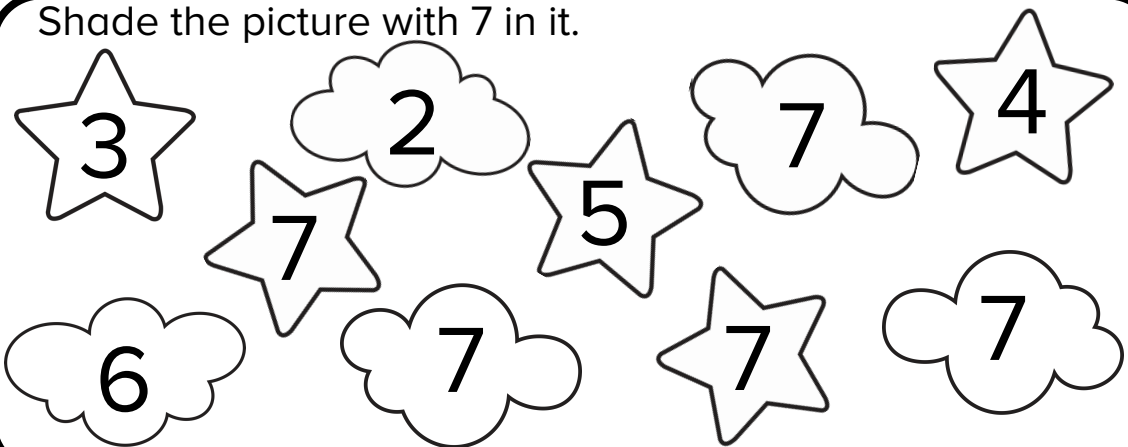

Circle the box with 7 picture in it.

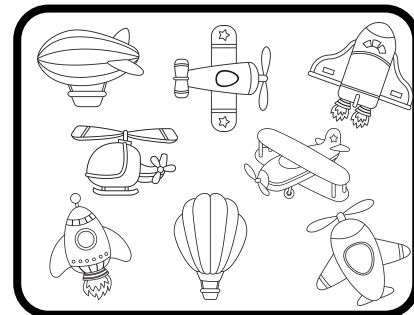
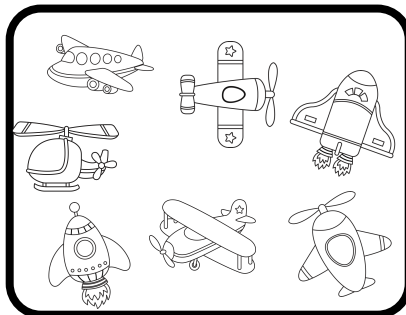
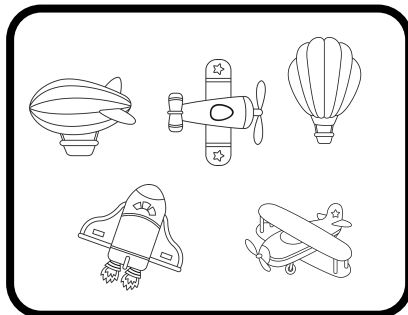
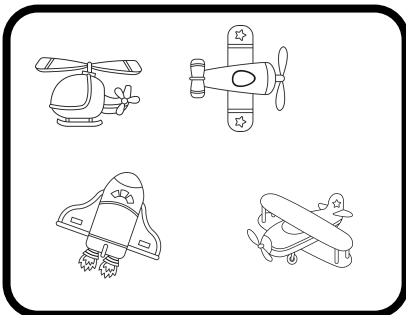

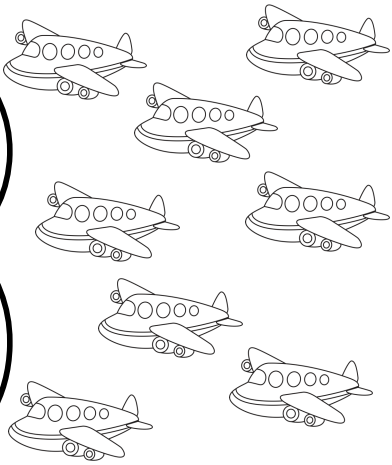
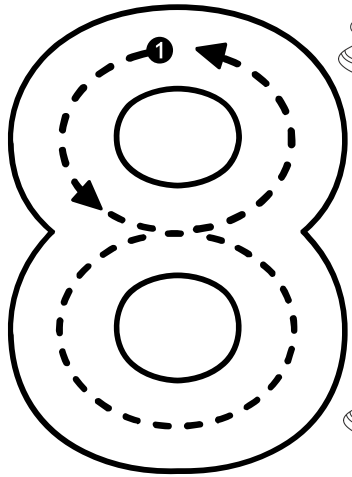

Shade the picture with 8 in it.

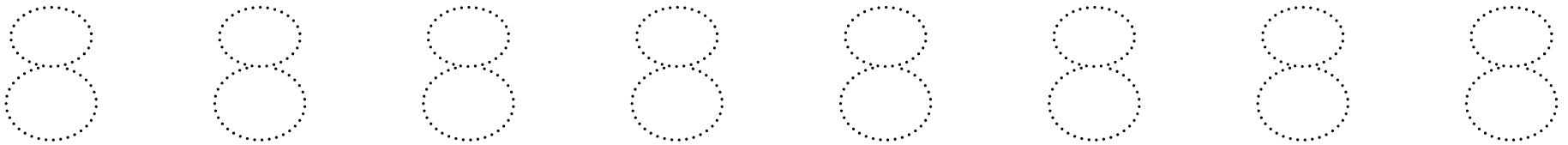
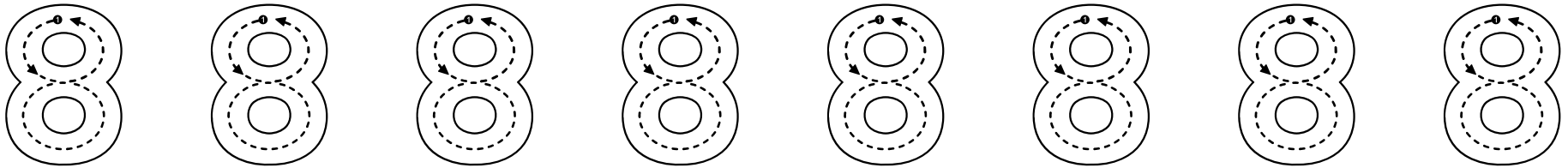
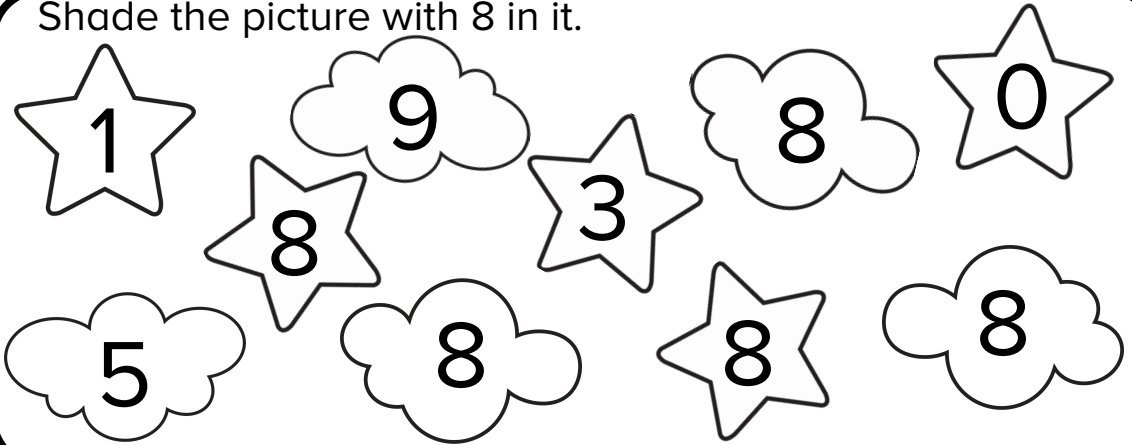

Circle the box with 8 picture in it.

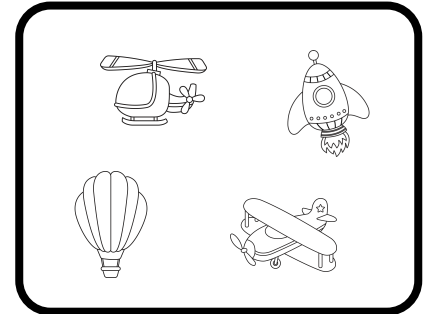
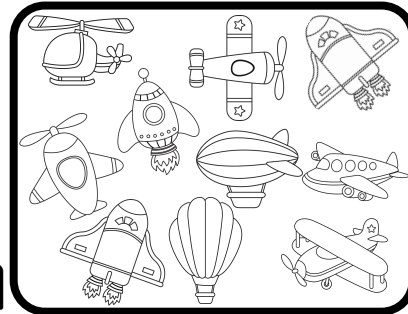
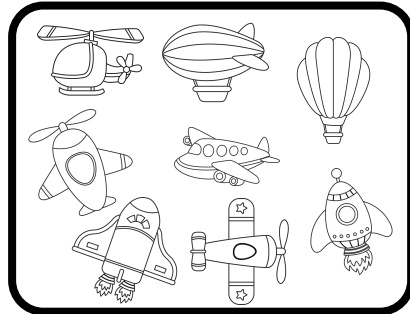
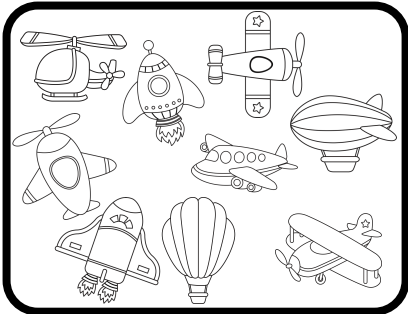

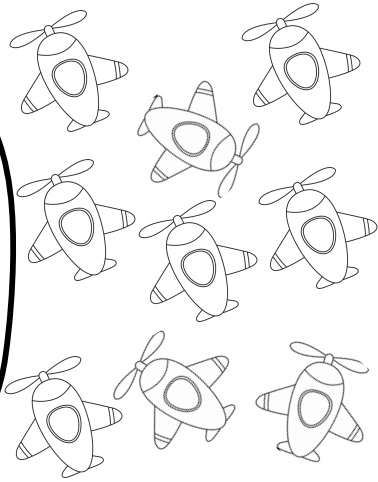
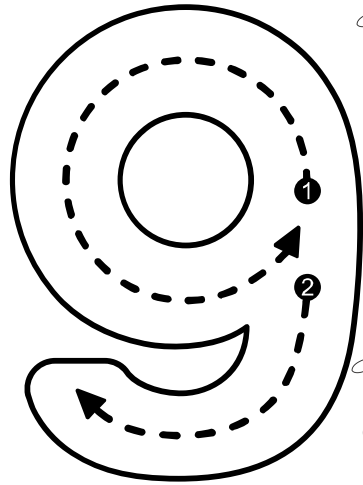

Shade the picture with 9 in it.

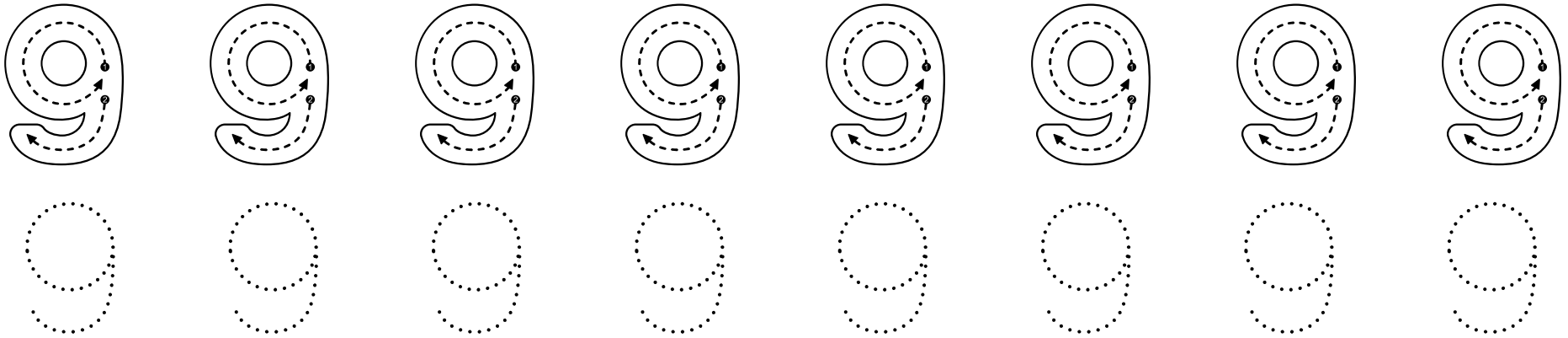
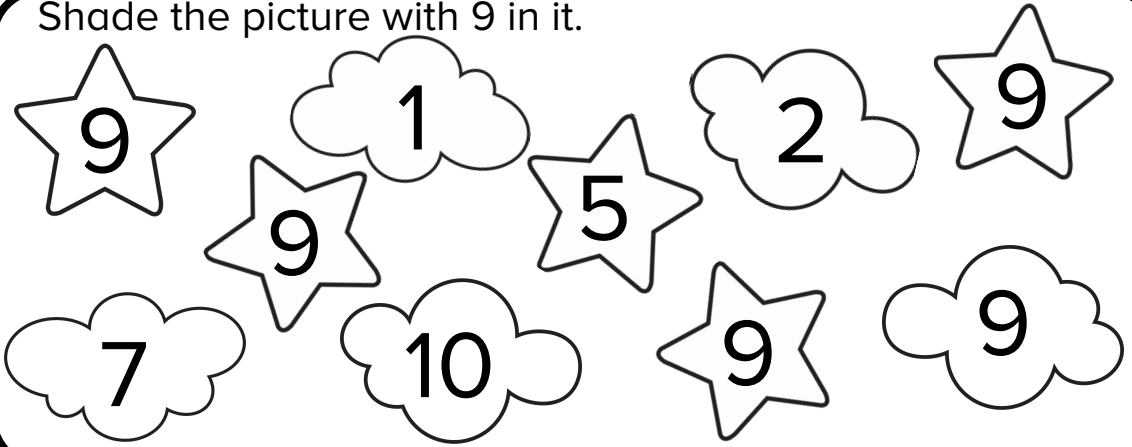

Circle the box with 9 picture in it.

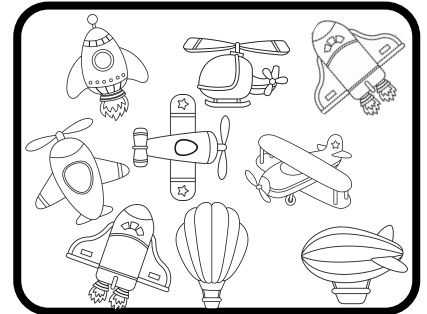
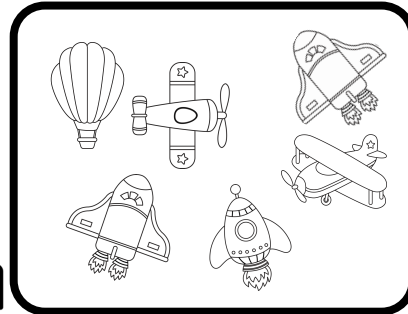
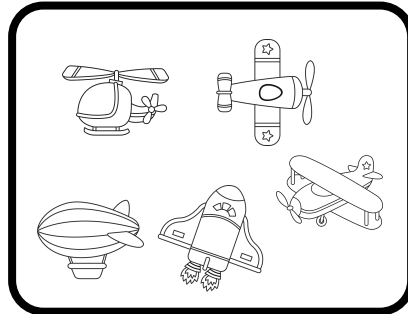
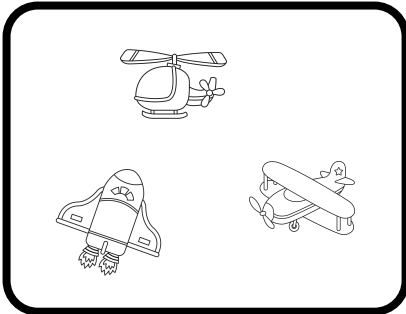

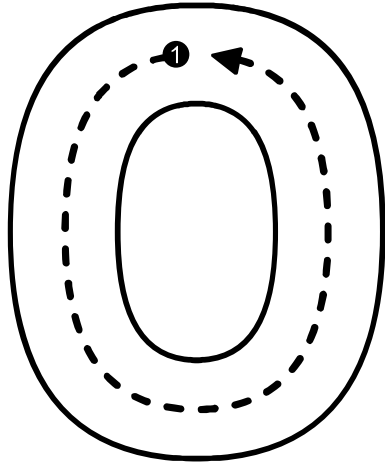
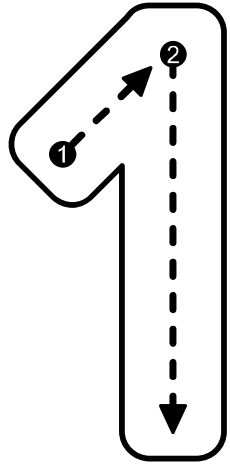

Shade the picture with 10 in it.

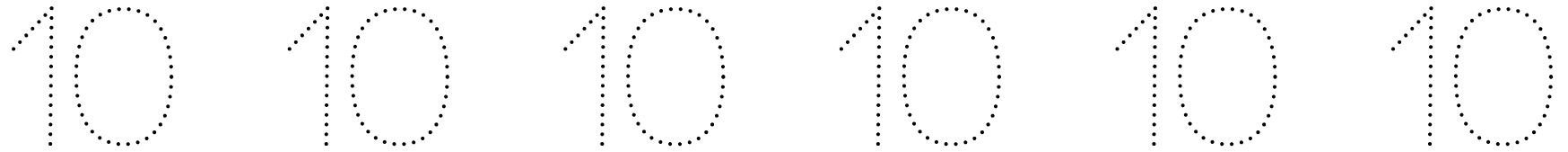
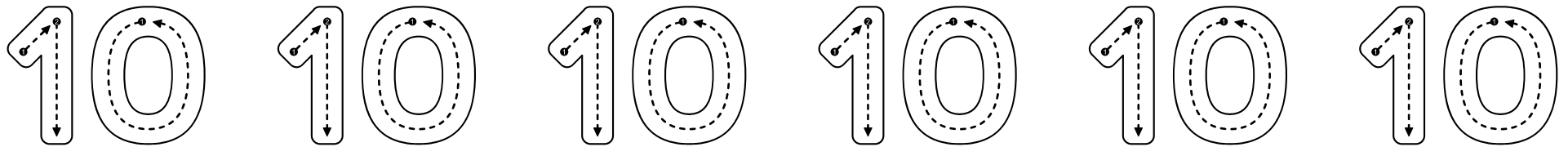
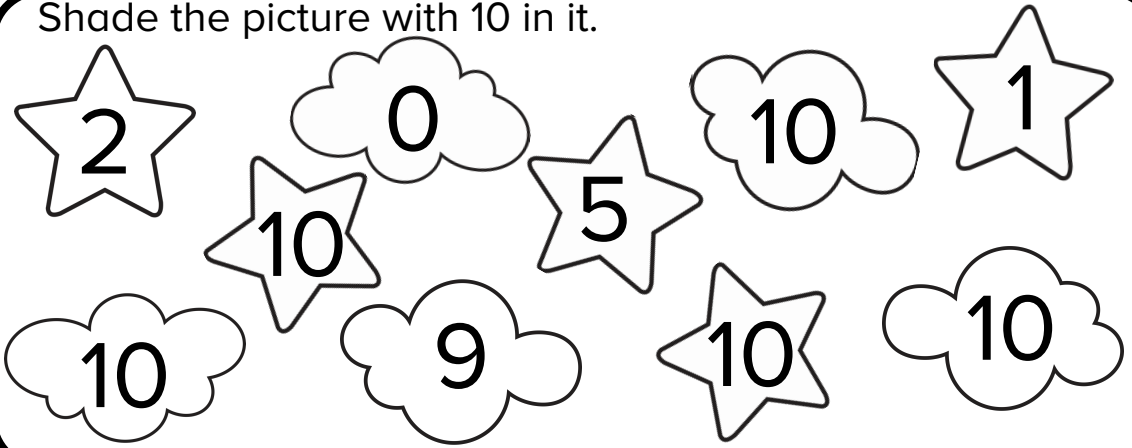

Circle the box with 10 picture in it.

